

ML240/ ML340/ ML240P/ ML340P Series
MA2400C/ MA3400C Series

**THERMAL TRANSFER / DIRECT
THERMAL BAR CODE PRINTER**

**SERVICE
MANUAL**

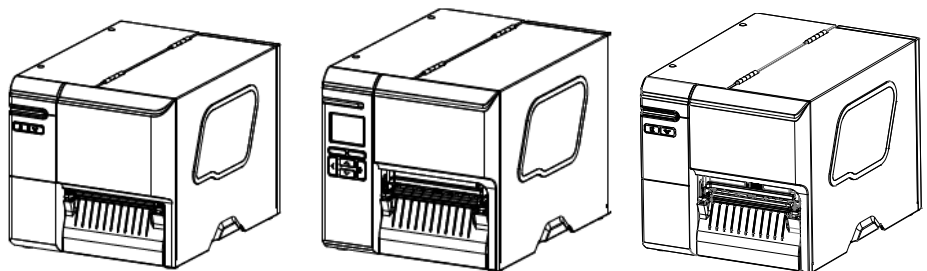

TABLE OF CONTENT

1. FUNDAMENTAL OF THE SYSTEM	1
1.1. Overview	1
2. ELECTRONICS	6
2.1 Summary of Board Connectors	6
2.2 Interface Pin Configuration	10
3. MECHANISM	11
3.1 Remove the Lower Front Panel.....	11
3.2 Remove the Electronics Cover	12
3.3 Replacing the Platen Roller Assembly	13
3.4 Replacing the Print head Module.....	15
3.5 Replacing the LED Panel Cover Assembly (ML240/ MA2400C Series).....	17
3.6 Replacing the LCD Panel Cover Assembly (ML240P Series)	19
3.7 Replacing the Label Supply Spindle	21
3.8 Replacing the Power Supply Unit.....	23
3.9 Replacing the Main Board	25
3.10 Replacing the Stepping Motor Assembly.....	26
3.11 Replacing the Gap/Black Mark Sensor Module	27
3.12 Bluetooth Module Installation (Option)	29
3.13 Cutter Module Installation (Option for ML240P/MA2400C Series)	31
3.14 Peel-off Sensor Module Installation (Option for ML240P/ MA2400C Series).....	33
4. TROUBLESHOOTING	35
4.1 Common Problems	35
4.2 Mechanism Fine Adjustment to Avoid Ribbon Wrinkles.....	38
4.2.1 Print Head Pressure Adjustment Knob	38
4.2.2 Use Ribbon Tension Adjustment Knob Module to avoid Ribbon Wrinkles	39
4.2.3 Mechanism Fine Adjustment to Avoid Ribbon Wrinkles	40
5. MAINTENANCE	42
UPDATE HISTORY	44

1. FUNDAMENTAL OF THE SYSTEM

1.1. Overview

Front View

For ML240/ MA2400C Series

For ML240/ ML340 Series



For MA2400C/ MA3400C Series (China area only)



1. LED indicator
2. Front panel buttons with icons
3. Media view window
4. Paper exit chute
5. Media cover handle

The diagram shows two front views of TSC industrial printers. The top image is for the ML240/ ML340 Series, and the bottom image is for the MA2400C/ MA3400C Series (China area only). Both images show a black printer with a paper label being printed. Red lines with numbers 1 through 5 point to specific features: 1. LED indicator (green), 2. Front panel buttons with icons (dashed red box), 3. Media view window (green), 4. Paper exit chute (black), and 5. Media cover handle (black).

For ML240P/ ML340P Series



- 1.** LED indicator
- 2.** LCD display
- 3.** Front panel buttons
- 4.** Media view window
- 5.** Paper exit chute
- 6.** Media cover handle

Interior View



Rear View

For ML240/ ML340 Series



1. External label entrance chute
2. Power switch
3. USB client interface (High speed mode)
4. Power cord socket

Note:
The interface picture here is for reference only. Please refer to the product specification for the interfaces availability.

For ML240P/ ML340P/ MA2400C/ MA3400C Series



- 1.** External label entrance chute
- 2.** Power switch
- 3.** USB interface (High speed mode)
- 4.** USB host
- 5.** RS-232 interface
- 6.** Slot-in Wi-Fi interface (Option)
- 7.** Ethernet interface
- 8.** Power cord socket

Note:

- The interface picture here is for reference only. Please refer to the product specification for the interfaces availability.
- The ML240C/ ML340C series models are sold in China area only.

2. ELECTRONICS

2.1 Summary of Board Connectors

Main board for ML240/ ML340 Series

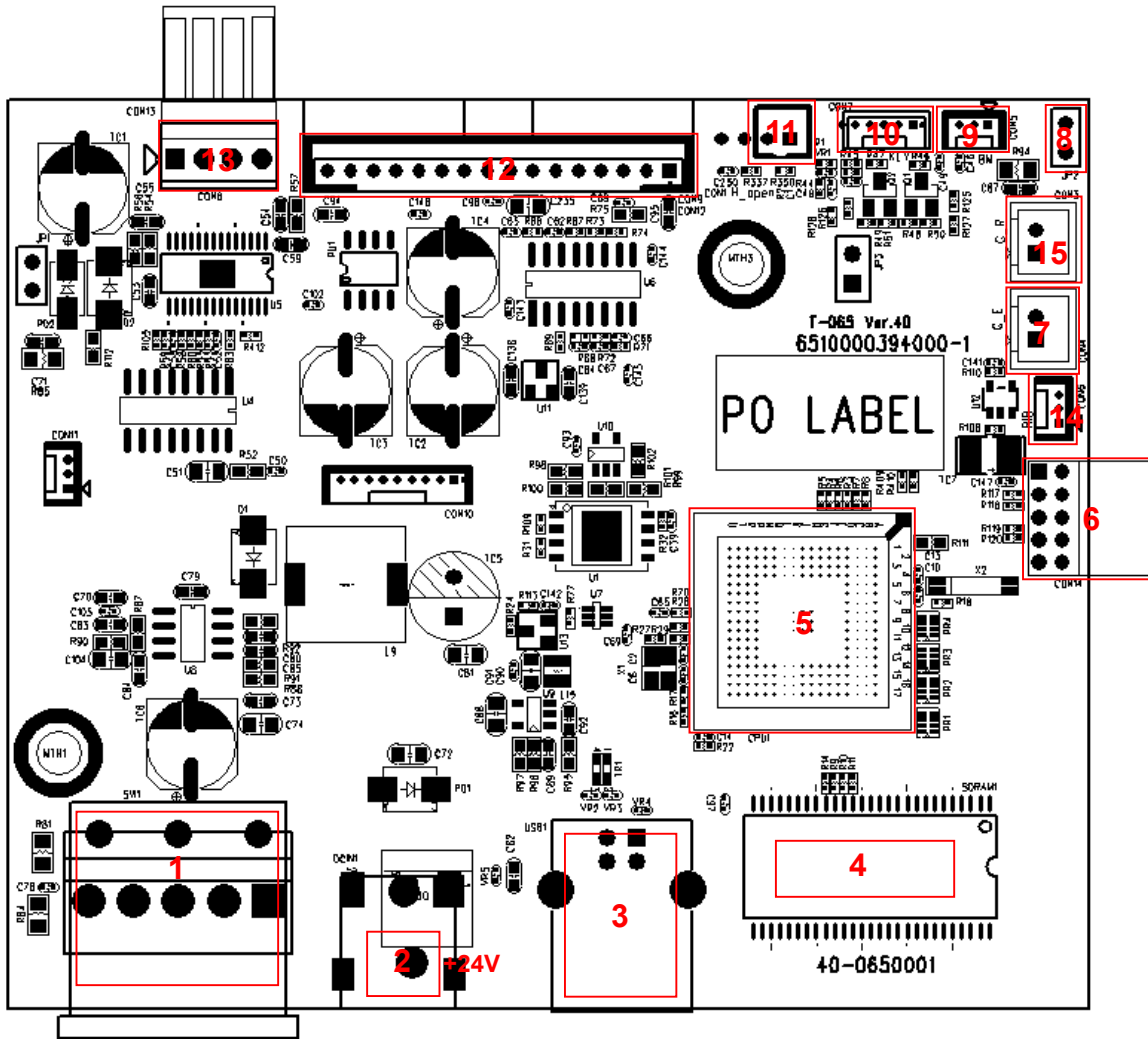

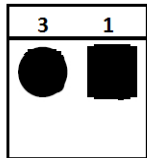
Connector	Description		Remark	
1	Power switch connector		SW1	
2	Power supply (24V DC) connector		DCIN2	
	 DCIN2	Pin name		CONFIGURATION
		1		+24V
3	USB Device connector		USB1	
4	SDRAM			

5	MCU	
6	BT connector	CON14
7	Gap sensor emit connector	CON4
8	ESD_GND_PIN	JP2
9	BM sensor connector	CON5
10	LED & KEY connector	CON7
11	Head open sensor connector	CON1
12	TPH connector	CON9
13	Step motor connector	CON13
14	Ribbon sensor connector	CON6
15	GAP Receive sensor connector	CON3

Main board for ML240P/ ML340P/ MA2400C/ MA3400C Series

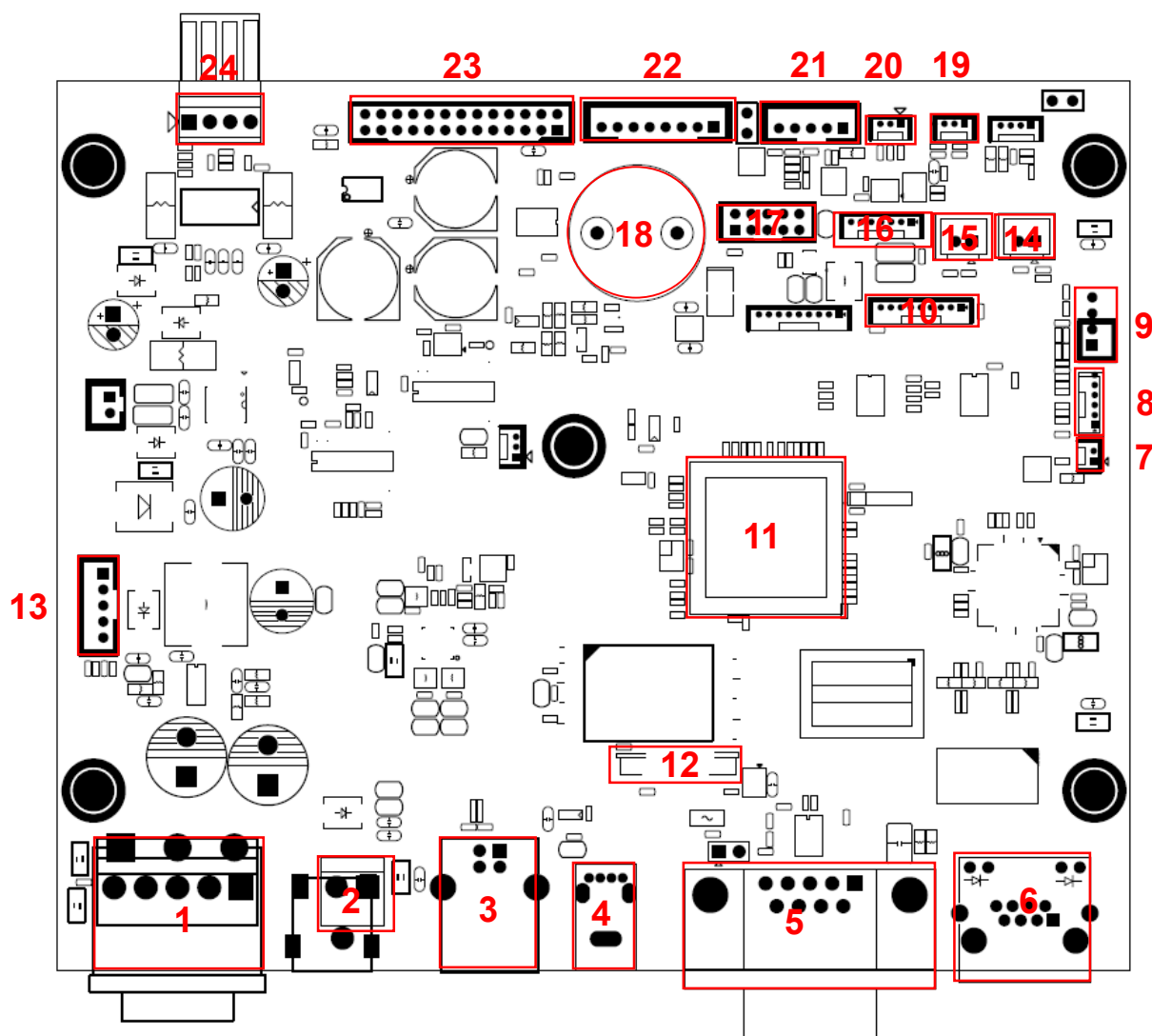

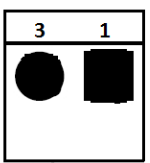
Connector	Description	Remark							
1	Power switch connector	SW1							
2	Power supply (24V DC) connector								
		<table border="1"> <thead> <tr> <th>Pin name</th> <th>CONFIGURATION</th> </tr> </thead> <tbody> <tr> <td>1</td> <td>+24V</td> </tr> <tr> <td>3</td> <td>GND</td> </tr> </tbody> </table>	Pin name	CONFIGURATION	1	+24V	3	GND	DCIN2
	Pin name	CONFIGURATION							
1	+24V								
3	GND								
3	USB client connector	USB1							
4	USB host connector	USB2							
5	RS-232C connector	RS1							

6	Ethernet connector	LAN1
7	RTC battery connector	BT1
8	LED & key & touch-function connector	CON19
9	Head open sensor connector	CON1
10	LCD panel (Interface 1, SPI LCD) connector	CON23
11	Micro processor	-
12	LCD panel (Interface 2, parallel LCD) connector	CON9
13	Liner rewinder connector	CON26
14	Gap receiver sensor connector	CON5
15	Gap emitter sensor connector	CON20
16	RFID connector	CON8
17	Wi-Fi / Bluetooth connector	CON13
18	Buzzer	BZ1
19	Ribbon end sensor connector	CON12
20	Black mark sensor connector	CON21
21	Peel-off sensor connector	CON10
22	Cutter connector	CON6
23	Print head connector	CON24
24	Stepping motor connector	CON16

2.2 Interface Pin Configuration

USB Device

PIN	CONFIGURATION
	1
2	D-
3	D+
4	GND

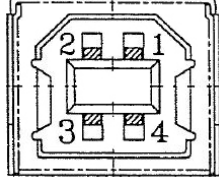

RS-232C

PIN	CONFIGURATION
1	+5 V
2	TXD
3	RXD
4	CTS
5	GND
6	RTS
7	N/C
8	RTS
9	N/C

USB Host

PIN	CONFIGURATION
	1
2	D-
3	D+
4	GND

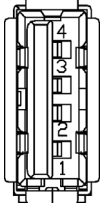

Ethernet

PIN	CONFIGURATION
1	Tx+
2	Tx-
3	Rx+
4	N/C
5	N/C
6	Rx-
7	N/C
8	N/C

3. MECHANISM

3.1 Remove the Lower Front Panel

1. Open the media cover.
2. Move the tab outward then pull the panel inward to remove the lower front panel.

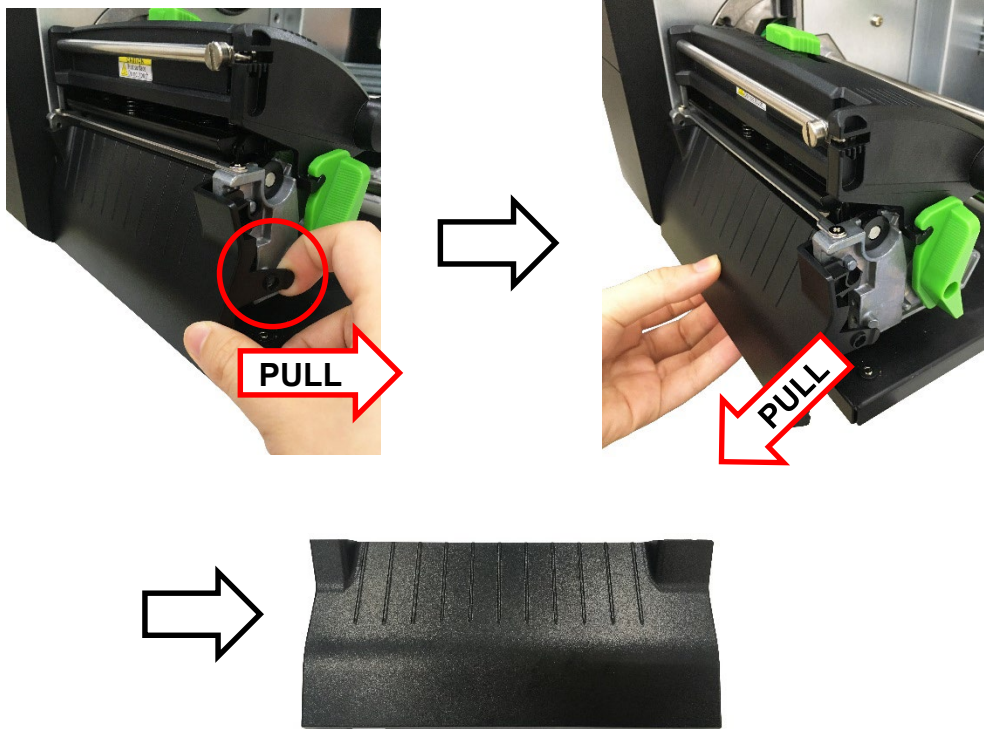

Lower front panel

3. Reassemble the parts in the reverse procedures.
Note: When install the lower front panel, please attach the hook along the protrusion of print head mechanism.

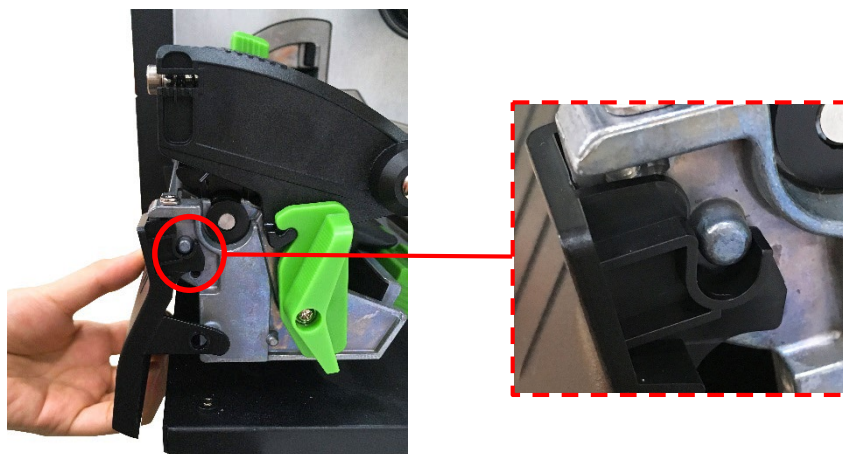

3.2 Remove the Electronics Cover

1. Open the printer right side cover and remove two screws on the electronic cover as indicated.

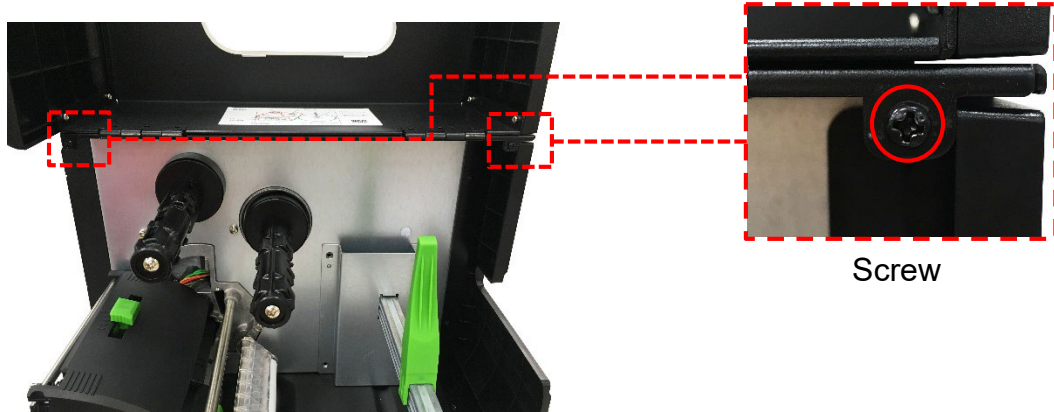

2. Turn the printer to left side and remove two screws on the electronic cover.

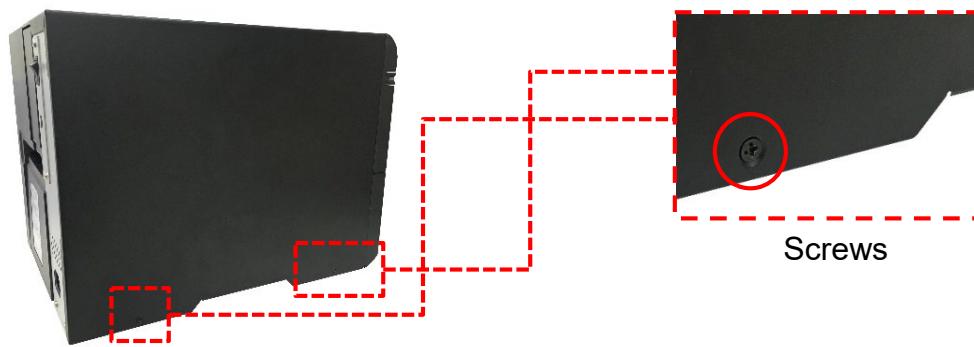

3. Remove the electronic cover.

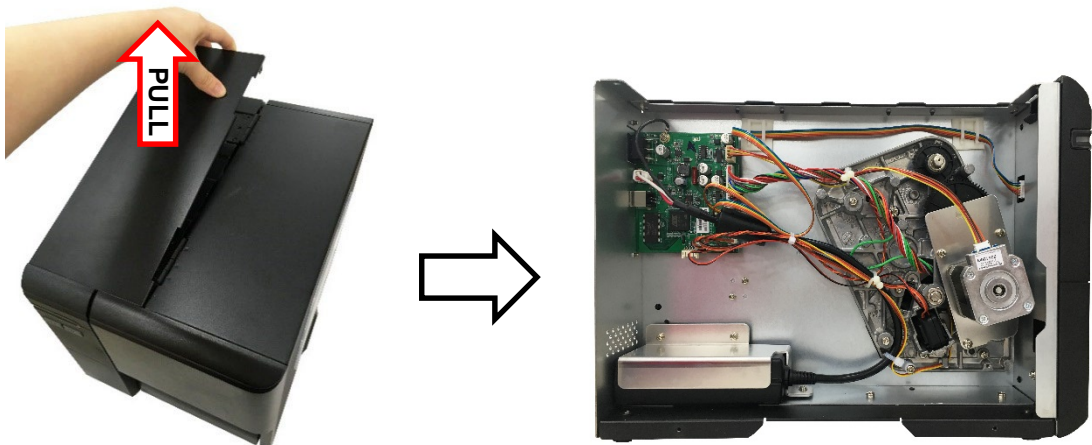

4. Reassemble the parts in the reverse procedures.

3.3 Replacing the Platen Roller Assembly

1. Open the media cover.
2. Refer to section 3.1 to remove the lower front panel.
3. Push the print head release lever to open the print head mechanism.

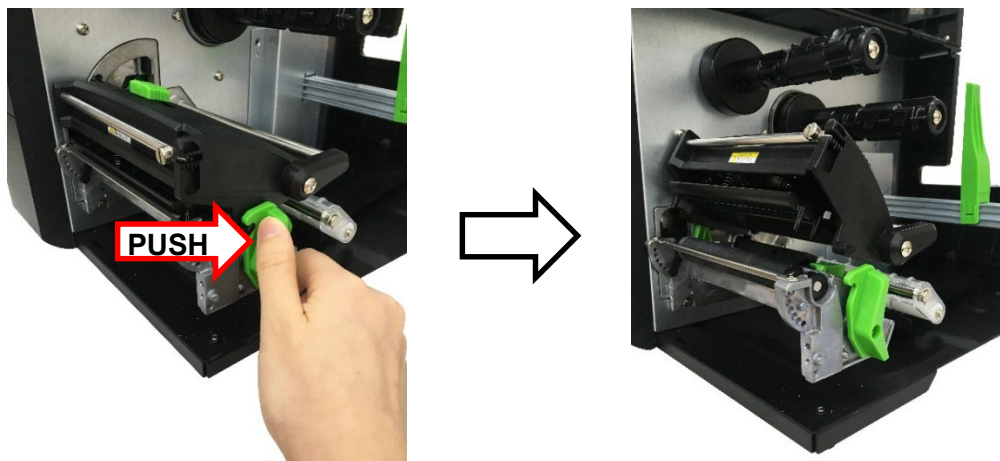

Lower front panel

4. Release the platen roller bush tabs then push it to the end of mechanism on both sides.

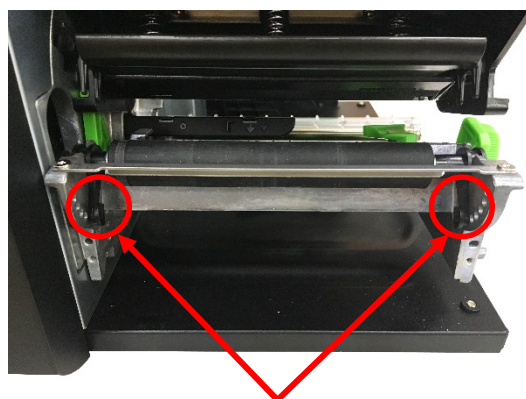

Platen roller bush tabs

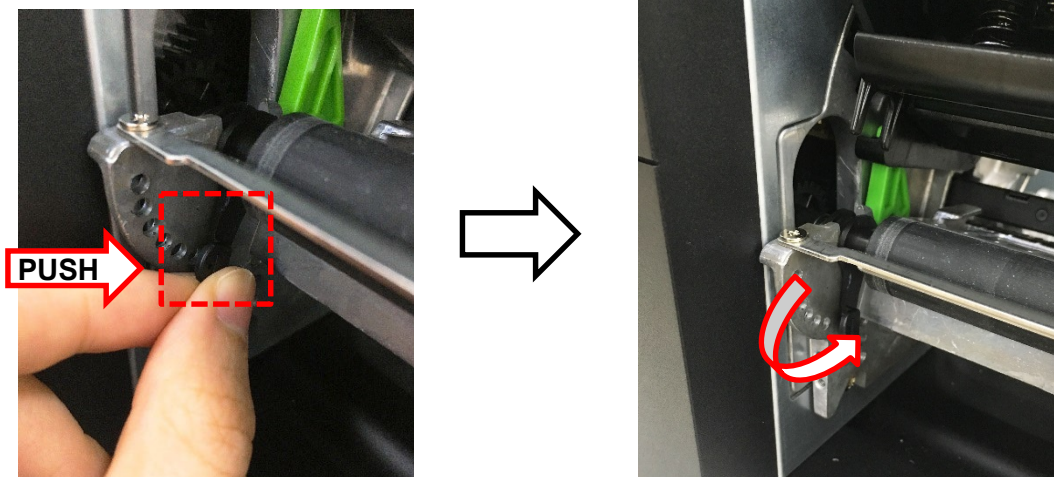

5. Pull up and remove platen roller assembly.

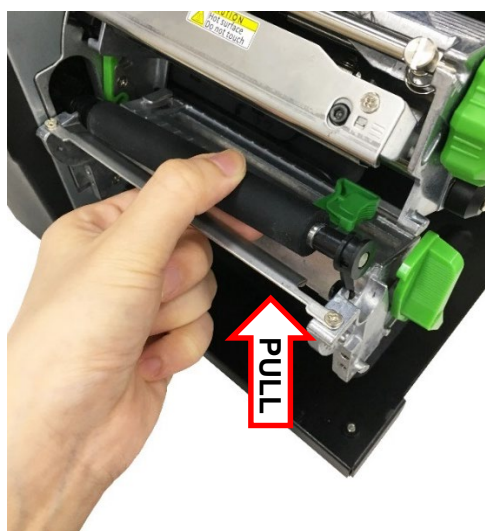

Platen roller assembly

6. Remove/Replace the platen roller assembly.
7. Reassemble the parts in the reverse procedures.

3.4 Replacing the Print head Module

1. Open the media cover.
2. Push the print head release lever to open the print head mechanism.

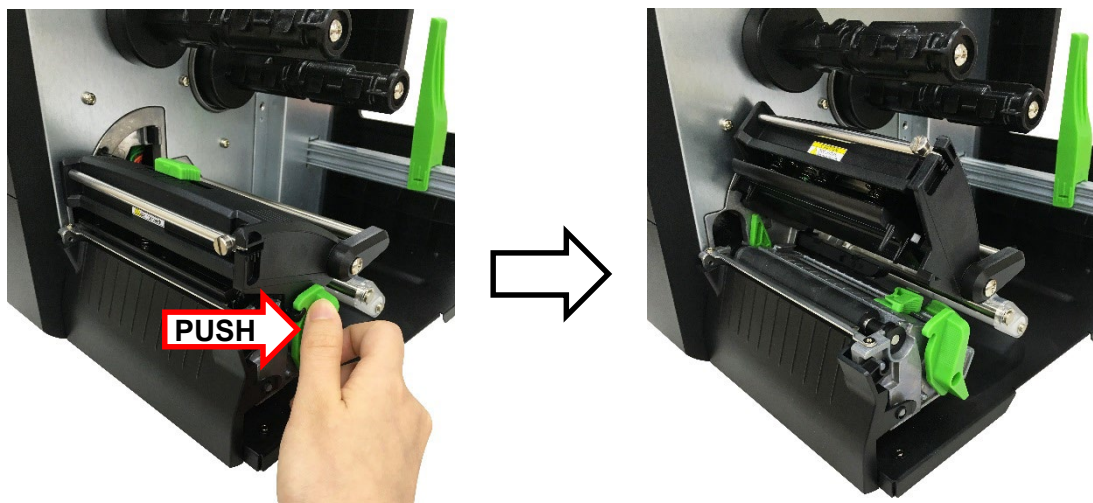

3. Release the print head module by removing the print head from the slots on both sides.

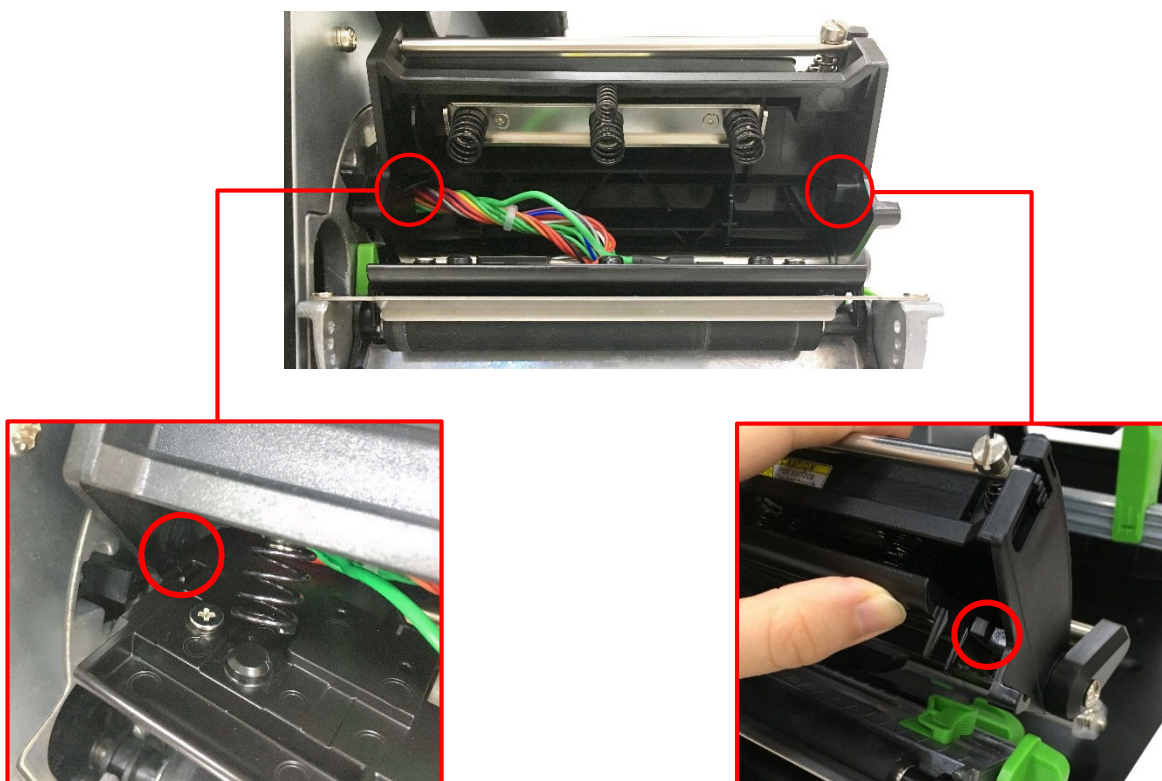

Left side slot

Right side slot

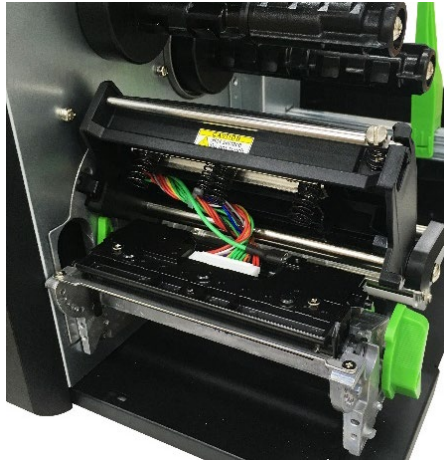
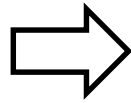

4. Remove the cable and ground wire on print head as indicated.
5. Remove/Replace the print head module.

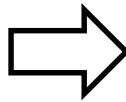
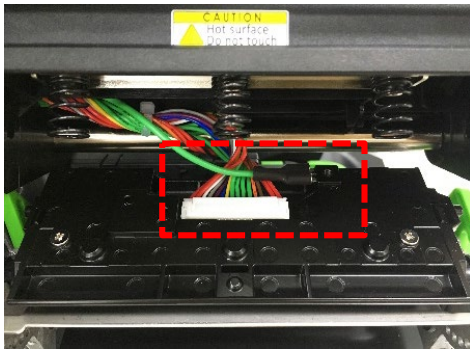

Print head module assembly

6. Reassemble the parts in the reverse procedures.
Note: It is suggested to reinstall on the left side slot first.



3.5 Replacing the LED Panel Cover Assembly (ML240/ MA2400C Series)

1. Refer to section 3.2 to remove the electronics cover.
2. Remove one screw on left front panel cover and disconnect one connector on LED panel board.

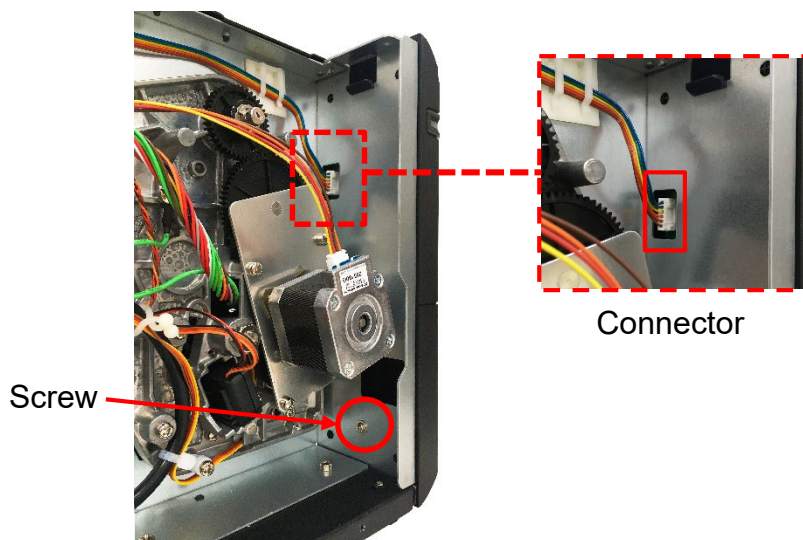

3. Remove the three screws connected on LED panel.



ML240/MA2400C Series
LED panel with three screws

Note: The MA2400C/ MA3400C series models are sold in China area only.

4. Remove/Replace the LED panel cover assembly.
 5. Reassemble the parts in the reverse procedures.
- Note: When reassemble the parts, please install the cable through the loading path as below.

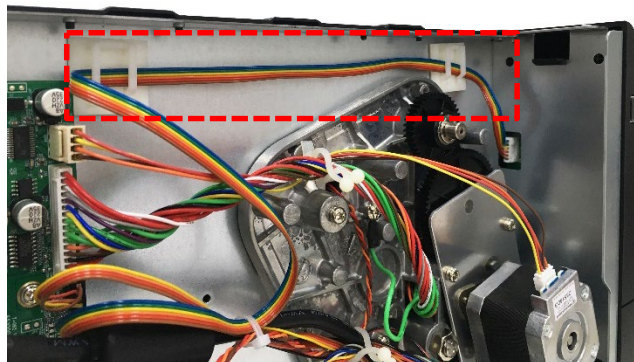

3.6 Replacing the LCD Panel Cover Assembly (ML240P Series)

1. Refer to section 3.2 to remove the electronics cover.
2. Remove one screw on left front panel cover and disconnect two connectors on LCD panel board.

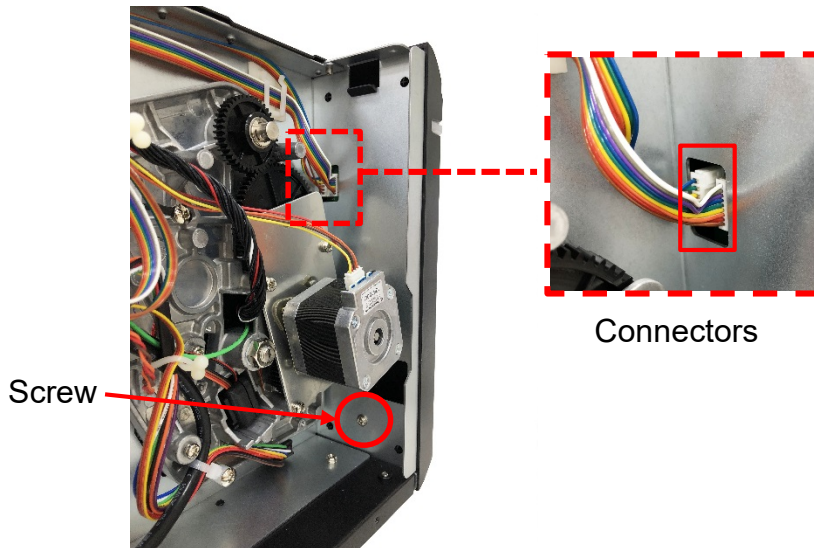

3. Remove the five screws connected on LCD panel.



ML240P Series
LCD panel with five screws

4. Remove/Replace the LCD panel cover assembly.
5. Reassemble the parts in the reverse procedures.

Note: When reassemble the parts, please install the cable through the loading path as below.

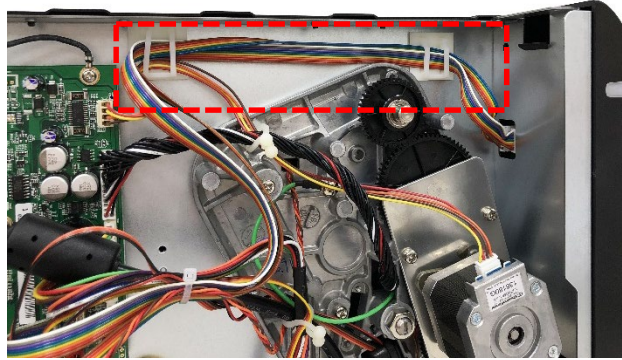

3.7 Replacing the Label Supply Spindle

1. Refer to section 3.2 to remove the electronics cover.



2. Remove the two screws on interface board (ML240P/ MA2400C series only).



3. Remove five screws and all connectors on the main board (ML240P/ MA2400C series only). **Note: The MA2400C/ MA3400C series models are sold in China area only.**

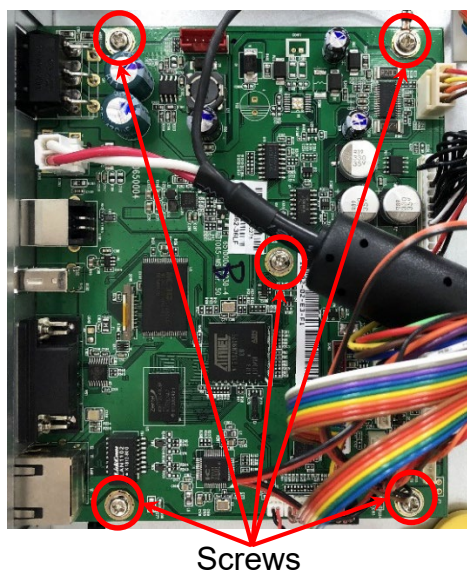

4. After removed the main board (ML240P/ MA2400C series only), please loosen the two screws as indicated to release label supply spindle.

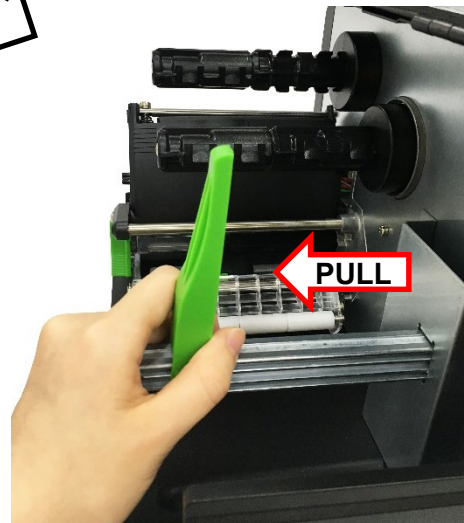
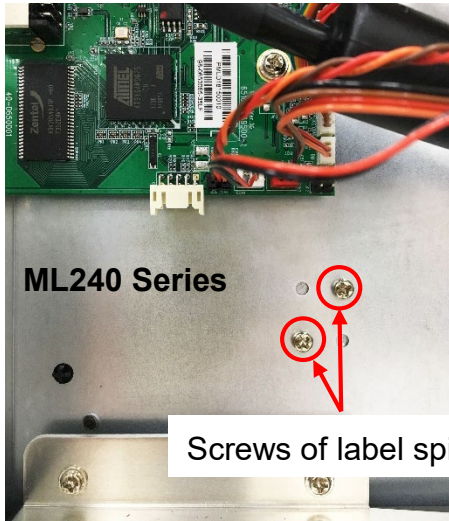

5. Remove/Replace the label supply spindle.



6. Reassemble the parts in the reverse procedures.

3.8 Replacing the Power Supply Unit

1. Refer to section 3.2 to remove the electronics cover.
2. Remove the three screws on power supply unit as indicated below.

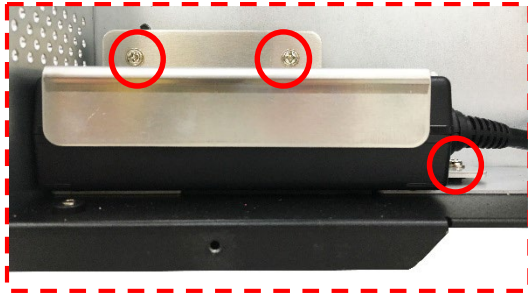

Screws

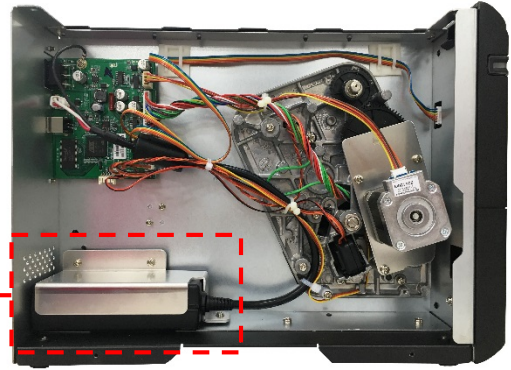

3. Remove one screw on mechanism as indicated.

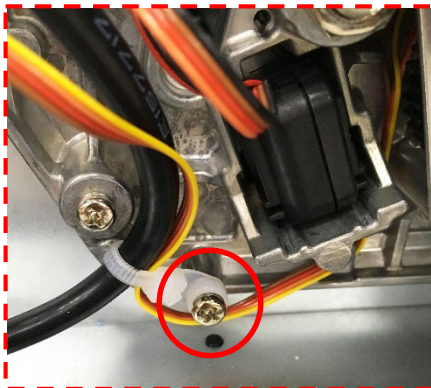

Screw

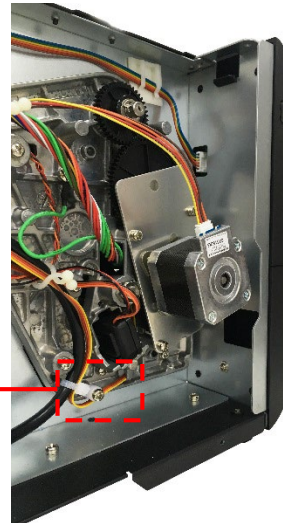

4. Remove the screw and one connector on main board as indicated to remove power supply unit.

ML240 Series

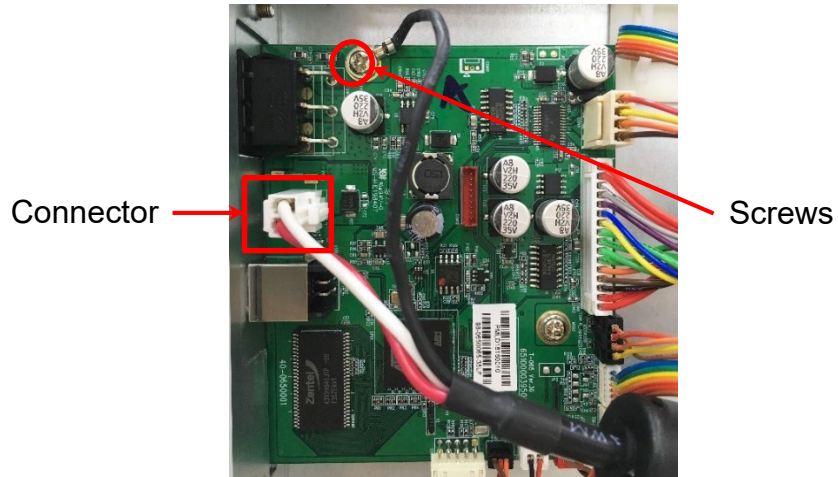

ML240P/ MA2400C Series

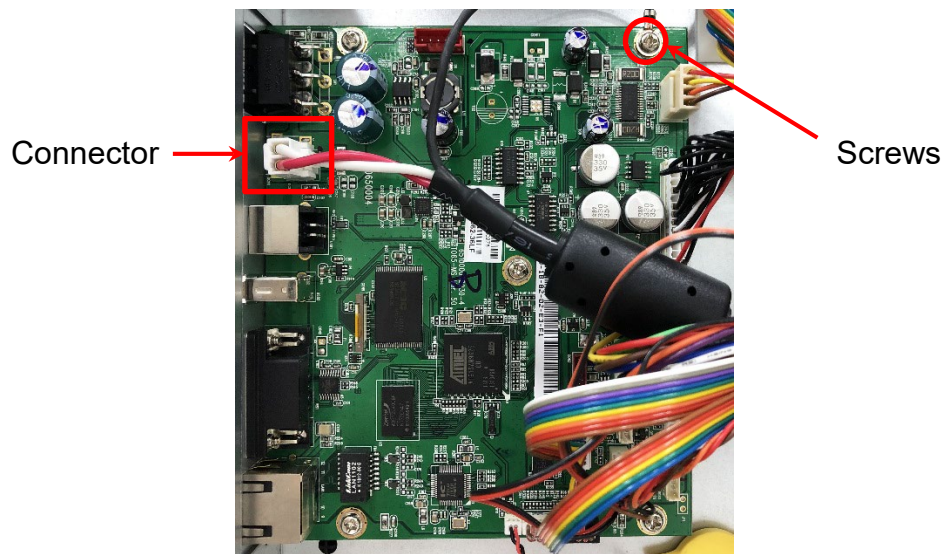

Note: The MA2400C/ MA3400C series models are sold in China area only.

5. Remove/Replace the power supply unit.
6. Reassemble the parts in the reverse procedures.

3.9 Replacing the Main Board

1. Refer to section 3.2 to remove the electronics cover.
2. Remove the two screws on interface board.



3. Remove all screws and connectors from the main board.

ML240 Series

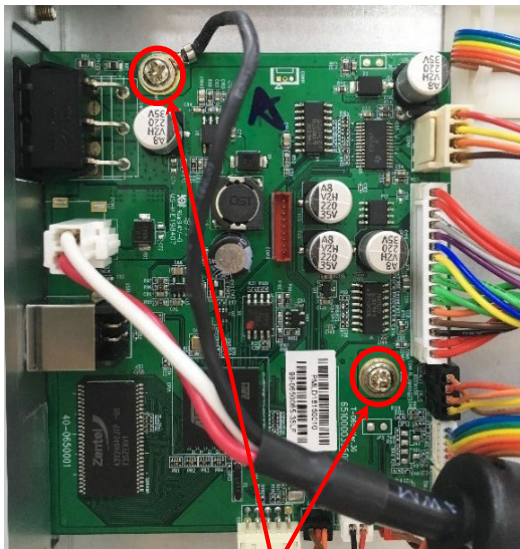

Screws

ML240P/ MA2400C Series

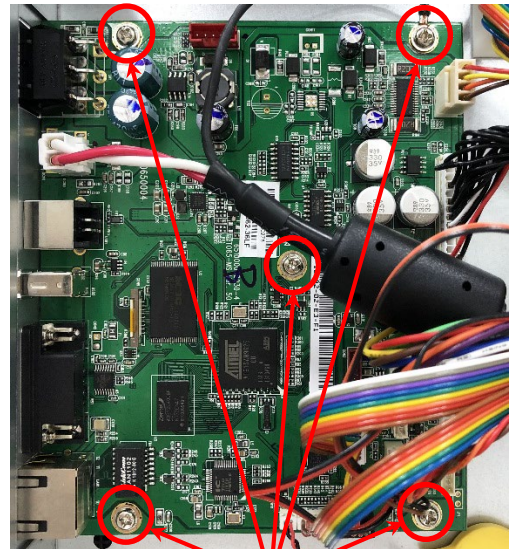

Screws

Note: The MA2400C/ MA3400C series models are sold in China area only.

4. Remove/Replace the main board.
5. Reassemble the parts in the reverse procedures.

3.10 Replacing the Stepping Motor Assembly

1. Refer to section 3.2 to remove the electronics cover.
2. Remove the four screws and one connector on the stepping motor assembly.

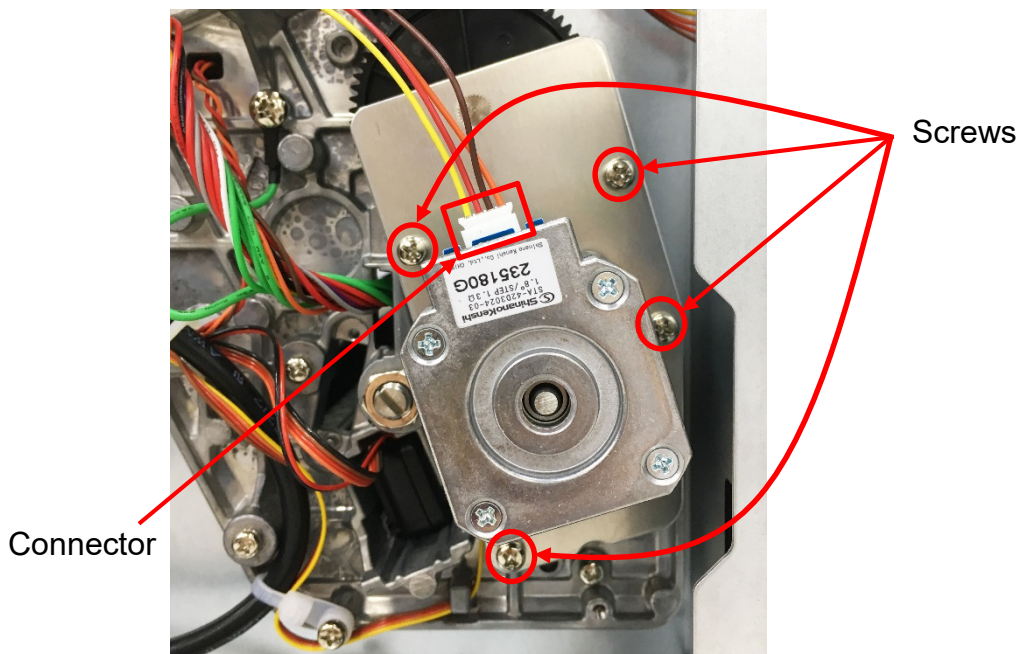

3. Remove/Replace the stepping motor assembly (including gears and stepping motor).



Stepping motor assembly

4. Reassemble the parts in the reverse procedures.

3.11 Replacing the Gap/Black Mark Sensor Module

1. Refer to section 3.1 to remove the lower front panel.
2. Refer to section 3.2 to remove the electronics cover.
3. Disconnect the gap/black mark sensor connectors from the main board.

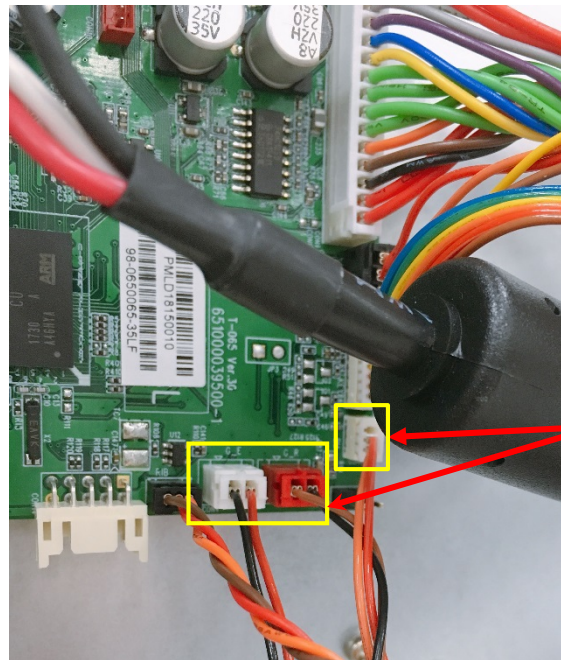

Gap/ Black mark sensor connectors

4. Open the media cover and push the latch as indicated, then push out the media sensor module to electronic side.

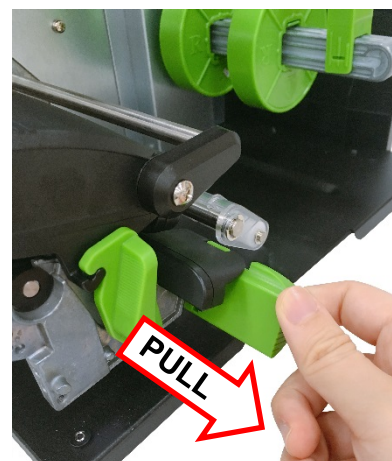
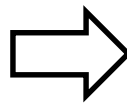

5. Remove/Replace the gap/black mark sensor.

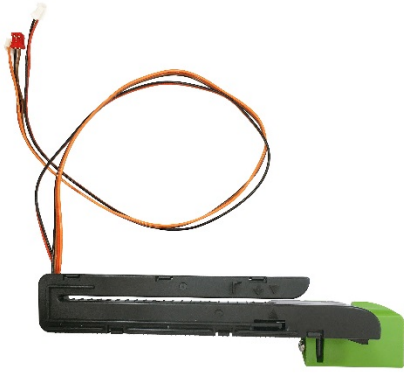

Media sensor module assembly

6. Reassemble the parts in the reverse procedures.

3.12 Bluetooth Module Installation (Option)

1. Refer to section 3.5 to remove the LCD Panel Cover Assembly.



2. Install the Bluetooth module on the slot and fix the two screws on Bluetooth board as indicated.

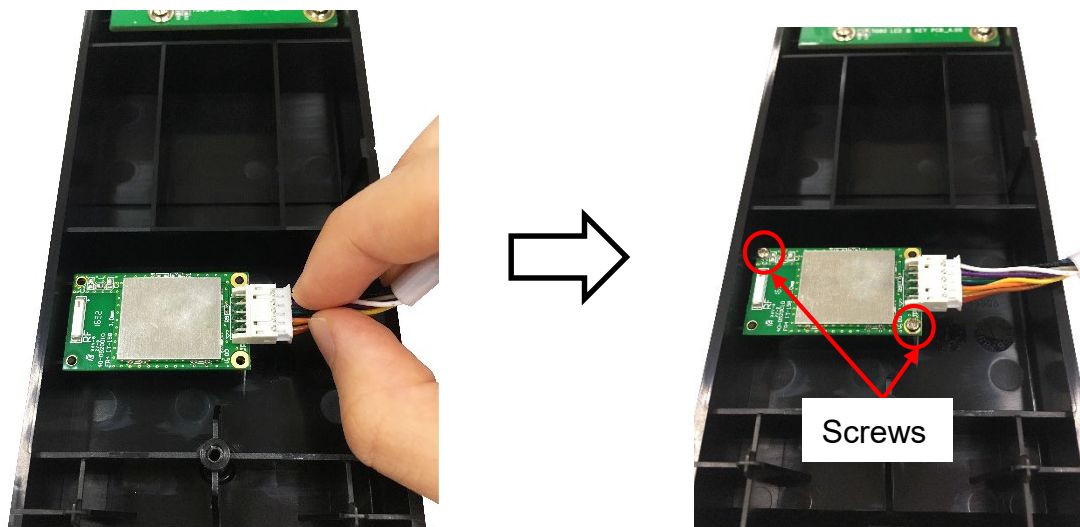

3. Install the cable through the LED panel cover board then connect to main board.

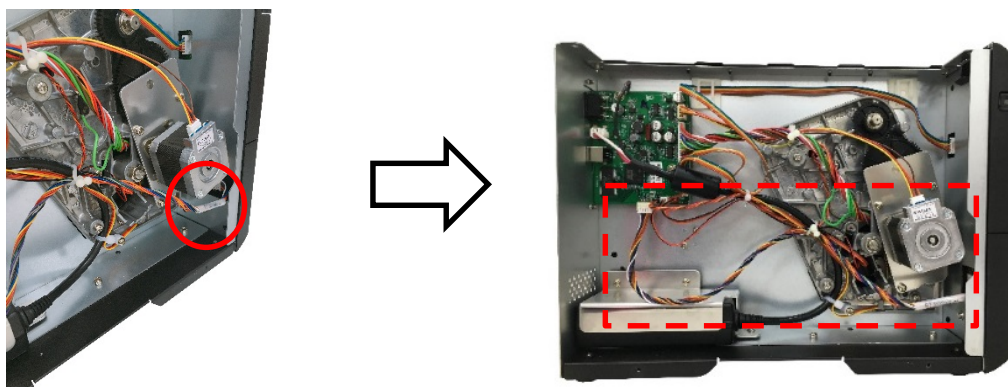

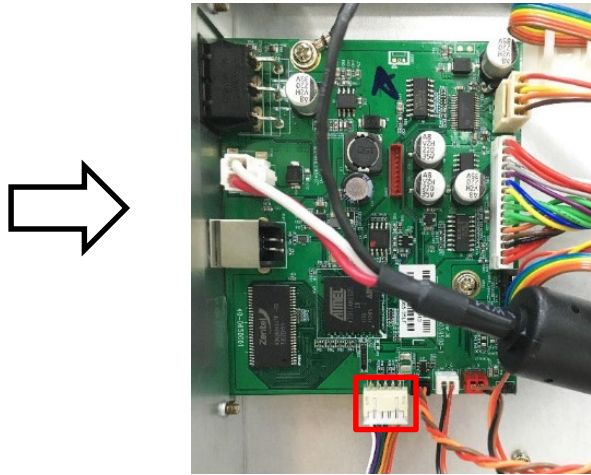

Note: Please connect the cable with “BT module” mark to LCD panel cover.

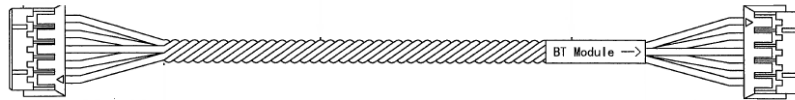

Bluetooth module with direction label

4. Remove/Replace the Bluetooth module.
5. Reassemble the parts in the reverse procedures.

3.13 Cutter Module Installation (Option for ML240P/MA2400C Series)

1. Open the media cover.
2. Refer to section 3.1 to remove the lower front panel.
3. Install the cable to cable connector as indicated.

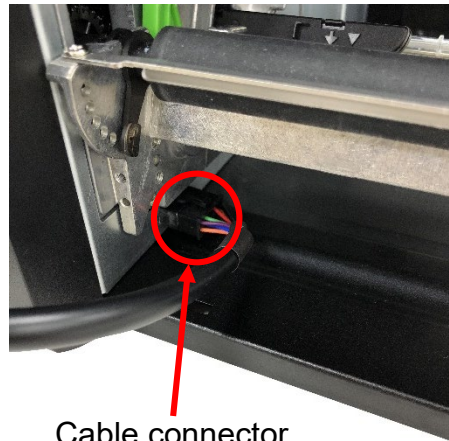

Cable connector

4. Place the cutter module on locating holes and fix two screws as indicated.

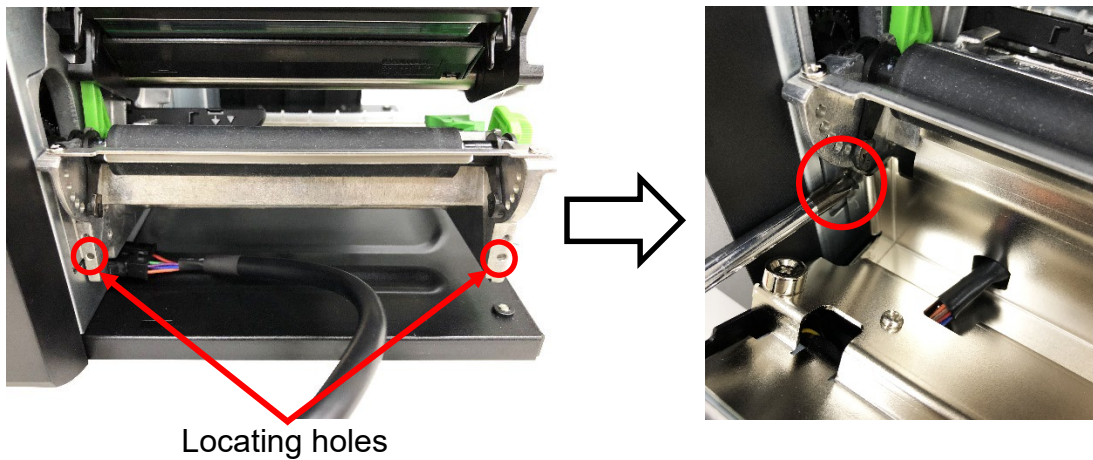

Locating holes

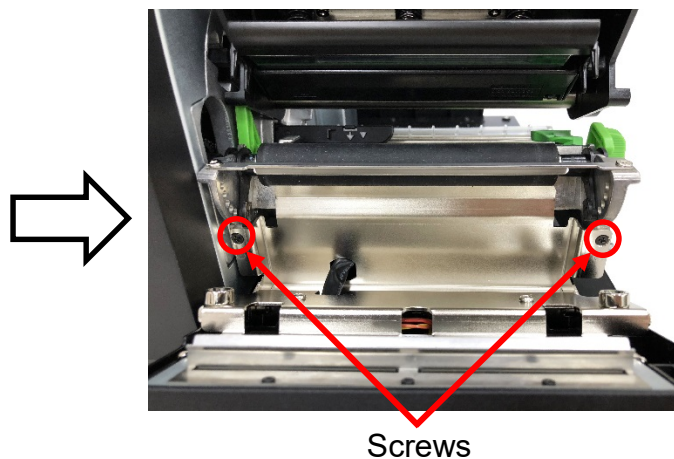

Screws

5. Close the cutter module and complete installation.

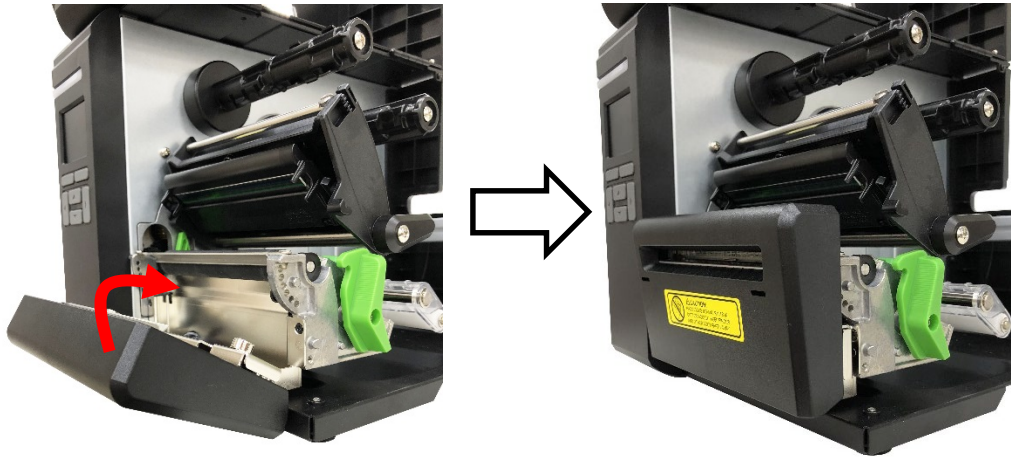

6. Remove/Replace the cutter module by the above reverse procedures.

3.14 Peel-off Sensor Module Installation (Option for ML240P/ MA2400C Series)

1. Open the media cover.
2. Refer to section 3.1 to remove the lower front panel.
3. Install the cable to cable connector as indicated.

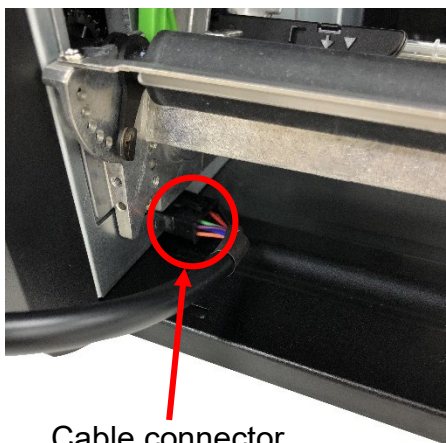

Cable connector

4. Place the peel-off sensor module on locating holes and fix two screws as indicated.

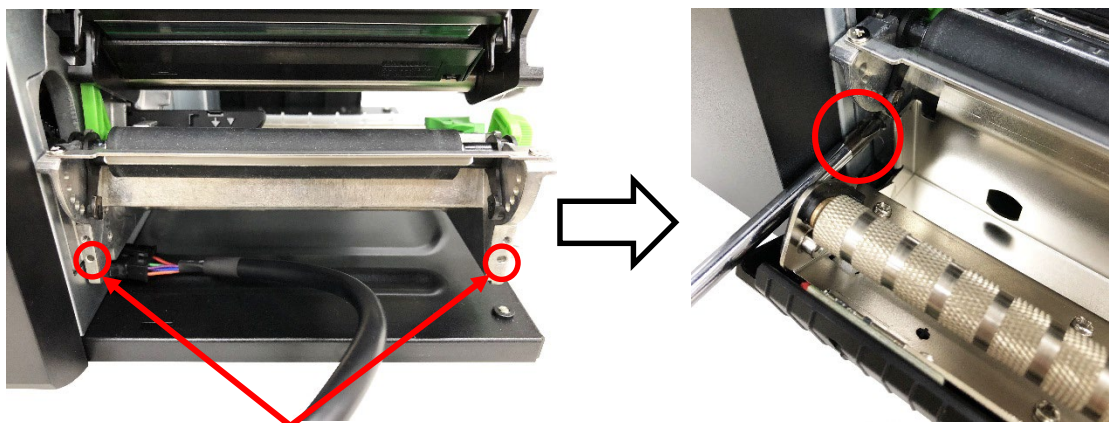

Locating holes

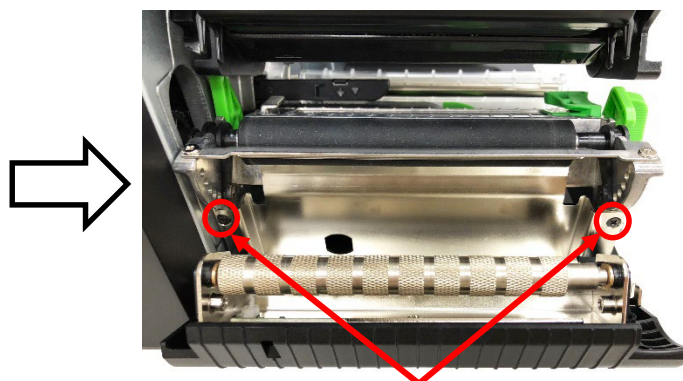

Screws

5. Close the peel-off sensor module and complete installation.

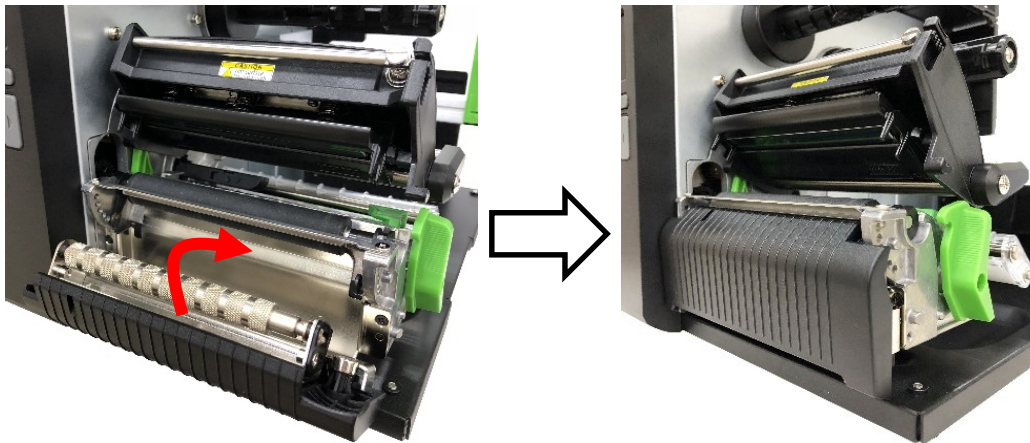

6. Remove/Replace the peel-off sensor module by the above reverse procedures.

4. TROUBLESHOOTING

4.1 Common Problems

The following guide lists the most common problems that might be encountered when operating this bar code printer. If the printer still does not function after all suggested solutions have been invoked, please contact the Customer Service Department of your purchased reseller or distributor for assistance.

Problem	Possible Cause	Recovery Procedure
Power indicator does not illuminate	<ul style="list-style-type: none"> * The power cord is not properly connected. 	<ul style="list-style-type: none"> * Plug the power cord in printer and outlet. * Switch the printer on.
Carriage Open	<ul style="list-style-type: none"> * The printer print head release lever is not engaged. 	<ul style="list-style-type: none"> * Please engage the print head release lever.
No Ribbon	<ul style="list-style-type: none"> * Running out of ribbon. * The ribbon is installed incorrectly. 	<ul style="list-style-type: none"> * Supply a new ribbon roll. * Please refer to the steps in user's manual to reinstall the ribbon.
No Paper	<ul style="list-style-type: none"> * Running out of label. * The label is installed incorrectly. * Gap/black mark sensor is not calibrated. * Gap/black mark sensor is not on the media. 	<ul style="list-style-type: none"> * Supply a new label roll. * Please refer to the steps in user's manual to reinstall the label roll. * Calibrate the gap/black mark sensor. * Align the media sensor on top of the media or black mark or notch.
Paper Jam	<ul style="list-style-type: none"> * Gap/black mark sensor is not set correctly for the media. * Make sure media width and height are set exactly same as actual media width and height. * Labels may be stuck inside the printer mechanism or media sensor. 	<ul style="list-style-type: none"> * Select the correct sensor for the media. * Calibrate the gap/black mark sensor. * Set media width and height correctly. * Remove the stuck label inside the print mechanism or at the media sensor.
Take Label	<ul style="list-style-type: none"> * Peel function is enabled. 	<ul style="list-style-type: none"> * If the peeler module is installed and function is enabled, please remove the peeled label. * If there is no peeler module installed, please switch off the printer and install it. * Check if the peeler module cable connector is plugged correctly.
UP: Fwd. DOWN: Rev. MENU: Exit	<ul style="list-style-type: none"> * There is no cutter installed on the printer. * Cutter PCB is damaged. 	<ul style="list-style-type: none"> * Remove the label. * Make sure the thickness of label is less than 200 g/m² (for regular cutter) or 300 g/m² (for heavy duty cutter). * Replace a cutter PCB.

<p>Not Printing</p>	<ul style="list-style-type: none"> * Cable is not well connected to serial or USB interface or parallel port. * The serial port cable pin configuration is not pin to pin connected. 	<ul style="list-style-type: none"> * Re-connect cable to interface. * Change a new cable. * Ribbon and media are not compatible. * Verify the ribbon-inked side. * Reload the ribbon again. * Clean the printhead. * The print density setting is incorrect. * Printhead's harness connector is not well connected with printhead. Turn off the printer and plug the connector again. * Check if the stepping motor is plugging in the right connector. * Check your program if there is a command PRINT at the end of the file and there must have CRLF at the end of each command line.
<p>Memory full (FLASH / DRAM)</p>	<ul style="list-style-type: none"> * The space of FLASH/DRAM is full. 	<ul style="list-style-type: none"> * Delete unused files in the FLASH/DRAM.
<p>Poor Print Quality</p>	<ul style="list-style-type: none"> * Ribbon and media is loaded incorrectly. * Dust or adhesive accumulation on the print head. * Print density is not set properly. * Print head element is damaged. * Ribbon and media are incompatible. * The print head pressure is not set properly. 	<ul style="list-style-type: none"> * Reload the supply. * Clean the print head. * Clean the platen roller. * Adjust the print density and print speed. * Run printer self-test and check the print head test pattern if there is dot missing in the pattern. * Change proper ribbon or proper label media. * Please refer to section 4.3 on user's manual for avoiding the ribbon wrinkle. * If the label thickness is more than 0.22 mm, the print quality might not be good enough, please adjust the heater line adjustment screw counter clockwise to get the best print quality. * The release lever does not latch the print head properly.
<p>LCD panel is dark and keys are not working.</p>	<ul style="list-style-type: none"> * The cable between main PCB and LCD panel is loose. 	<ul style="list-style-type: none"> * Check if the cable between main PCB and LCD is secured or not.
<p>LCD panel is dark but the LEDs are light.</p>	<ul style="list-style-type: none"> * The printer initialization is unsuccessful. 	<ul style="list-style-type: none"> * Turn OFF and ON the printer again. * Initialize the printer.
<p>Ribbon encoder sensor doesn't work.</p>	<ul style="list-style-type: none"> * The ribbon encoder sensor connector is loose. 	<ul style="list-style-type: none"> * Fasten the connector.
<p>Ribbon end sensor doesn't work.</p>	<ul style="list-style-type: none"> * The connector is loose. * The ribbon sensor hole is covered with dust. 	<ul style="list-style-type: none"> * Check the connector. * Clear the dust in the sensor hole by the blower.
<p>Peel sensor is not working.</p>	<ul style="list-style-type: none"> * Peel sensor is not located on the correct position. * The connector is loose. 	<ul style="list-style-type: none"> * Make sure that the media goes through the Peel sensor. * Plug the connect cable correctly.
<p>Cutter is not working.</p>	<ul style="list-style-type: none"> * The connector is loose. 	<ul style="list-style-type: none"> * Plug in the connect cable correctly.
<p>Label feeding is not stable (skew) when printing.</p>	<ul style="list-style-type: none"> * The media guide does not touch the edge of the media. 	<ul style="list-style-type: none"> * If the label is moving to the right side, please move the label guide to left. * If the label is moving to the left side, please move the label guide to right.

Skip labels when printing.	<ul style="list-style-type: none"> * Label size is not specified properly. * Sensor sensitivity is not set properly. * The media sensor is covered with dust. 	<ul style="list-style-type: none"> * Check if label size is setup correctly. * Calibrate the sensor by Auto Gap or Manual Gap options. * Clear the GAP/Black mark sensor by blower.
Missing printing on the left or right side of label.	<ul style="list-style-type: none"> * Wrong label size setup. 	<ul style="list-style-type: none"> * Set the correct label size.
Multi interface board doesn't work.	<ul style="list-style-type: none"> * The installation is incorrect. 	<ul style="list-style-type: none"> * Check if the board is plugged in the right connector.
Power and Error LEDs are blinking fast.	<ul style="list-style-type: none"> * Power switch OFF and ON too fast. 	<ul style="list-style-type: none"> * Turn off the printer and wait all LEDs are dark, and turn on the printer again.
Wrinkle Problem	<ul style="list-style-type: none"> * Printhead pressure is incorrect. * Ribbon installation is incorrect. * Media installation is incorrect. * Print density is incorrect. * Media feeding is incorrect. 	<ul style="list-style-type: none"> * Please refer to chapter 4.2. * Please set the suitable density to have good print quality. * Make sure the label guide touch the edge of the media guide.
Gray line on the blank label	<ul style="list-style-type: none"> * The printhead is dirty. * The platen roller is dirty. 	<ul style="list-style-type: none"> * Clean the printhead. * Clean the platen roller.
Irregular printing	<ul style="list-style-type: none"> * The printer is in Hex Dump mode. 	<ul style="list-style-type: none"> * Turn off and on the printer to skip the dump mode.

4.2 Mechanism Fine Adjustment to Avoid Ribbon Wrinkles

4.2.1 Print Head Pressure Adjustment Knob

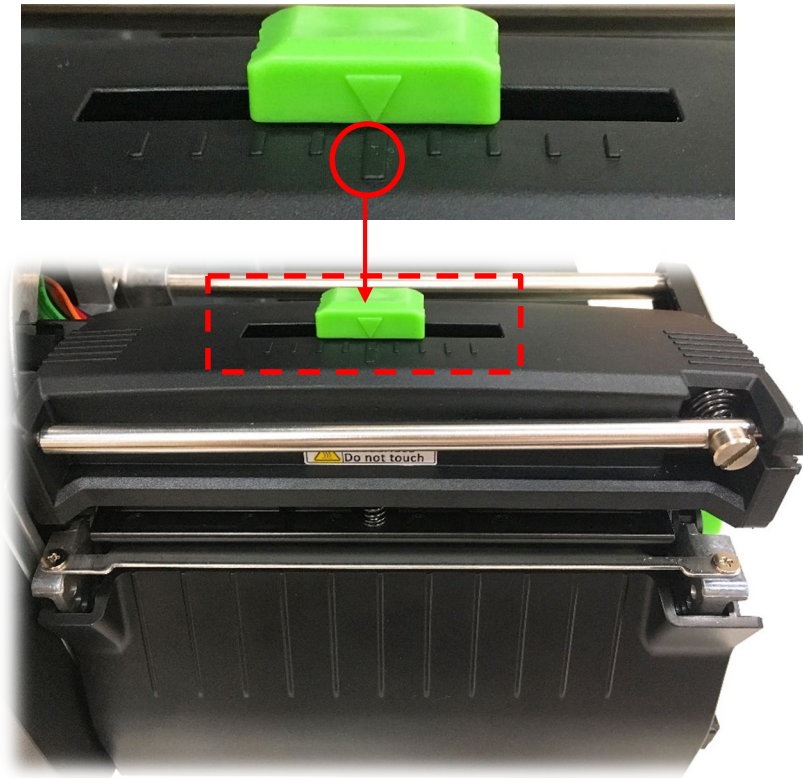

The print head pressure adjustment knob has nine positions from left to right. Because the printer's paper alignment is to the left side of mechanism, different media widths require the different pressure to print the label correctly. Therefore, it may require adjusting pressure position to get the best print quality.

4.2.2 Use Ribbon Tension Adjustment Knob Module to avoid Ribbon Wrinkles

Ribbon Tension Adjustment Knob has five positions for adjustment. Because the printer's ribbon alignment is to the left side of mechanism, different ribbon or media widths require different ribbon tension to print correctly. Therefore, it may require adjust the ribbon tension adjustment knob to avoid wrinkle and get the best print quality.

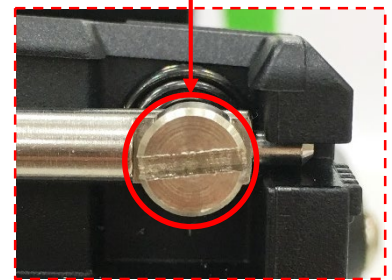

Ribbon Tension Adjustment

4.2.3 Mechanism Fine Adjustment to Avoid Ribbon Wrinkles

This printer has been fully tested before delivery. There should be no ribbon wrinkle presented on the media for general-purpose printing application. Ribbon wrinkle is related to the media width, thickness, print head pressure balance, ribbon film characteristics, print darkness setting...etc. In case the ribbon wrinkle happens, please follow the instructions below to adjust the printer parts.

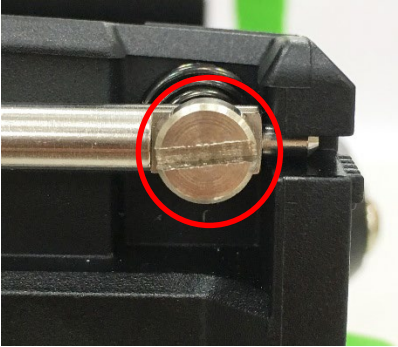
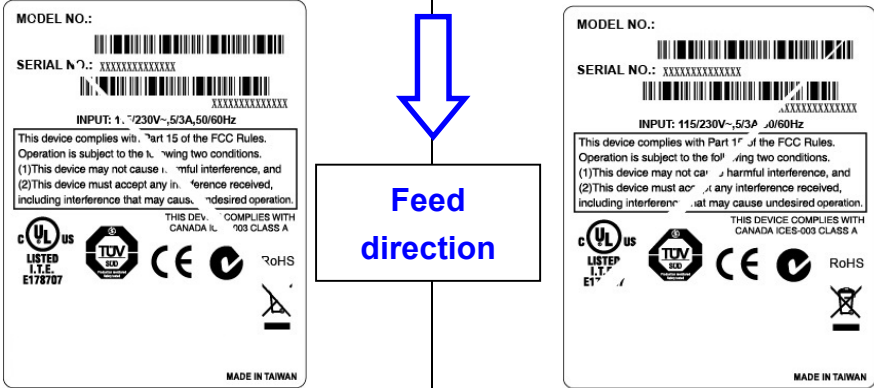
<p>Adjustable Printer Parts</p>	<p>Ribbon Tension Adjustment Knob has five positions for adjustment. Use flat blade driver to change the ribbon tension position.</p> <div style="display: flex; justify-content: space-around;">   </div> <div style="display: flex; justify-content: space-around; margin-top: 10px;"> <p>Ribbon Tension Adjustment</p> <p>Ribbon Tension Adjustment Knob</p> </div>	
<p>Symptom</p>	<p>1. Wrinkle happens from label lower right to upper left direction (“ ` ”)</p>	<p>2. Wrinkle happens from label lower left to upper right direction (“ ´ ”)</p>
<p>Wrinkle Example</p>	<div style="display: flex; align-items: center; justify-content: center;"> <div style="border: 1px solid black; padding: 5px; margin-right: 20px;"> <p style="text-align: center; color: blue; font-weight: bold;">Feed direction</p> </div>  </div>	

If the wrinkle on the label starts from the lower right side to upper left side, please do following adjustment.

1. Switch the ribbon tension adjustment knob clockwise per 1 level and print the label again to check if the wrinkle is gone.

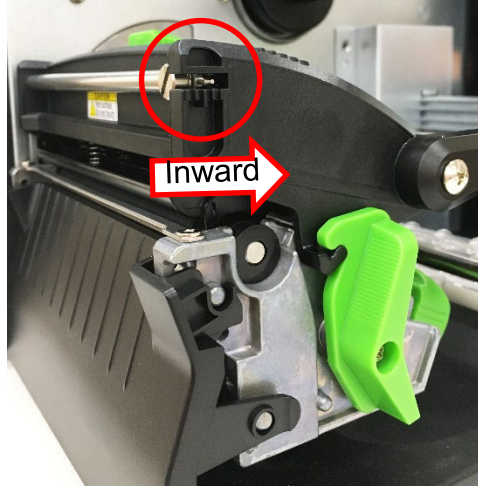

2. If the ribbon tension adjustment knob has positioned on the level of innermost side but didn't improve the ribbon wrinkle, please switch the print head pressure adjustment knob per 1 level and print the label again to check if the wrinkle is gone.
3. If the wrinkle can't be avoided, please contact the Customer Service Department of your purchased reseller or distributor for service.

If the wrinkle on the label starts from the lower left side to upper right side, please do following adjustment.

1. Switch the ribbon tension adjustment knob counterclockwise per 1 level and print the label again to check if the wrinkle is gone.

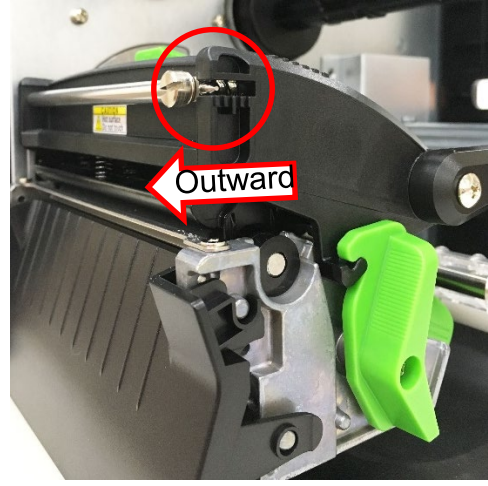

2. If the ribbon tension adjustment knob has positioned on the level of outermost side but didn't improve the ribbon wrinkle, please switch the print head pressure adjustment knob per 1 level and print the label again to check if the wrinkle is gone.
3. If the wrinkle can't be avoided, please contact the Customer Service Department of your purchased reseller or distributor for service.

5. MAINTENANCE

This session presents the clean tools and methods to maintain your printer.

1. Please use one of following material to clean the printer.
 - Cotton swab (Head cleaner pen)
 - Lint-free cloth
 - Vacuum / Blower brush
 - 100% ethanol

2. The cleaning process is described as following

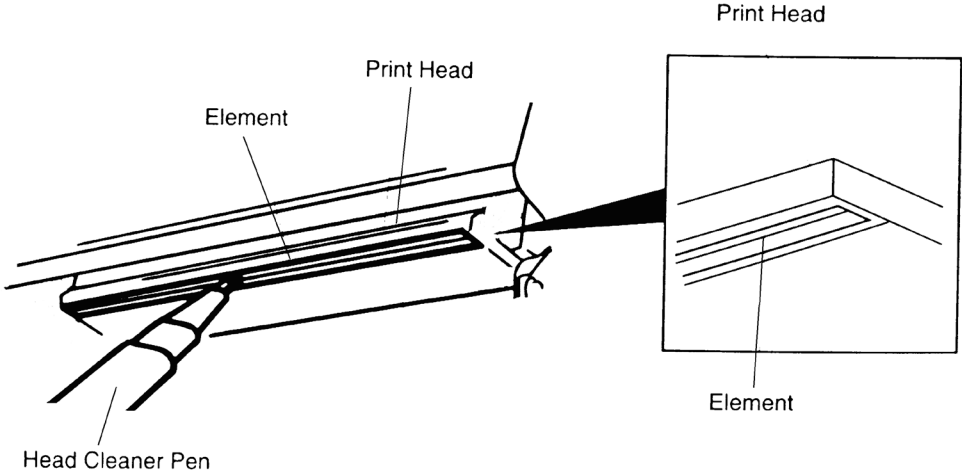
Printer Part	Method	Interval
<p>Print Head</p>	<ol style="list-style-type: none"> 1. Always turn off the printer before cleaning the print head. 2. Allow the print head to cool for a minimum of one minute. 3. Use a cotton swab (Head cleaner pen) and 100% ethanol to clean the print head surface. 	<p>Clean the print head when changing a new ribbon roll.</p>
	 <p>The diagram illustrates the cleaning process for the print head. It shows a perspective view of the print head assembly with a 'Head Cleaner Pen' being used to clean the 'Print Head' surface. An 'Element' is also labeled. An inset shows a close-up of the 'Print Head' and 'Element'.</p>	
<p>Platen Roller</p>	<ol style="list-style-type: none"> 1. Turn the power off. 2. Rotate the platen roller and wipe it thoroughly with a cotton swab, or lint-free cloth soaked with clean water. 	<p>Clean the platen roller when changing a new ribbon roll.</p>
<p>Tear Bar/Peel Bar</p>	<p>Use the lint-free cloth with 100% ethanol to wipe it.</p>	<p>As needed</p>
<p>Sensor</p>	<p>Compressed air blower or</p>	<p>Monthly</p>

	vacuum	
Exterior	Wipe it with water-dampened cloth	As needed
Interior	Brush or vacuum	As needed

Note:

- Do not touch printer head by bare hand. If you touch it careless, please use ethanol to clean it.
- Please use 100% Ethanol. DO NOT use medical alcohol, which may damage the printer head.
- Regularly clean the print head and supply sensors once change a new ribbon to keep printer performance and extend print head life.



TSC Auto ID Technology Co., Ltd.

Corporate Headquarters

9F., No.95, Minquan Rd., Xindian Dist.,
New Taipei City 23141, Taiwan (R.O.C.)

TEL: +886-2-2218-6789

FAX: +886-2-2218-5678

Web site: www.tscprinters.com

E-mail: printer_sales@tscprinters.com
tech_support@tscprinters.com

Li Ze Plant

No.35, Sec. 2, Ligong 1st Rd., Wujie Township,
Yilan County 26841, Taiwan (R.O.C.)

TEL: +886-3-990-6677

FAX: +886-3-990-5577